

OPERAÇÕES COM IVA LIQUIDADO

1 - PELA FACTURA AO CLIENTE

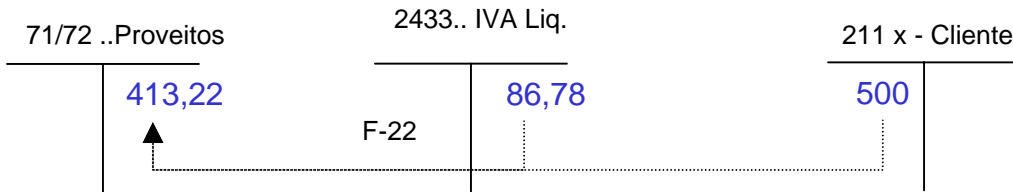

2 - LIQUIDAÇÃO DA RECEITA E COBRANÇA

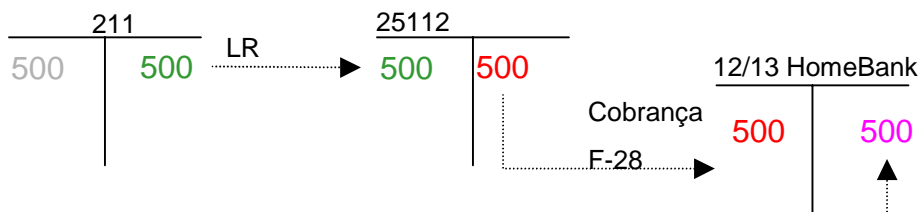

3 - PELA ENTREGA DA RECEITA AO ESTADO (UEO)

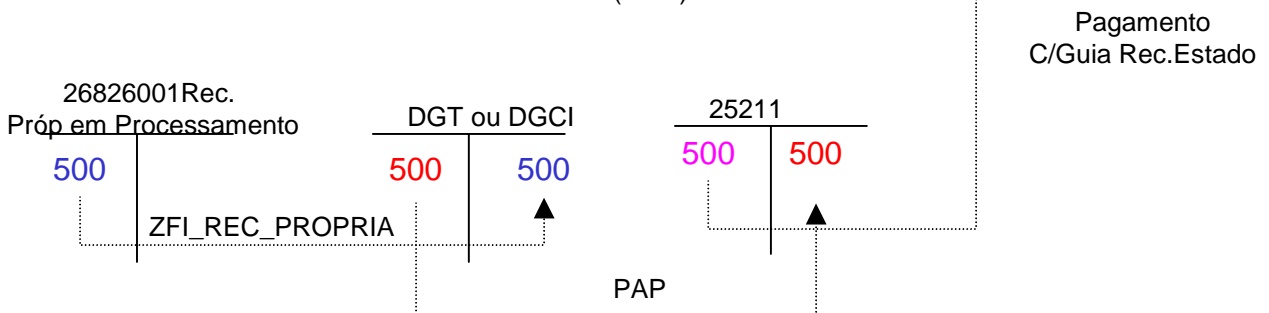

4 - REGISTO DA GUIA DE RECEITA DE ESTADO APÓS PAGAMENTO (CFin)

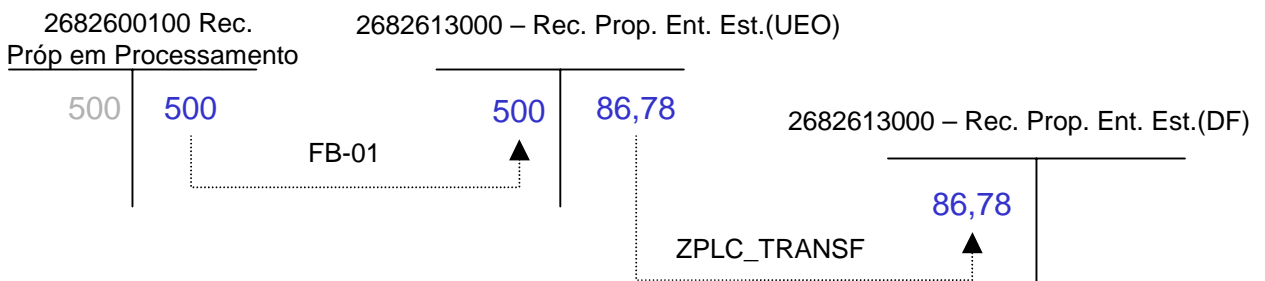

1 – CABIMENTO E COMPROMISSO (C/IVA DEDUTÍVEL)

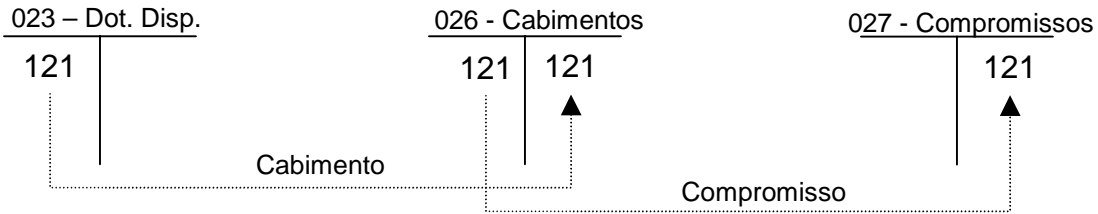

2 – PROCESSAMENTO DA FACTURA (C/IVA DEDUTÍVEL)

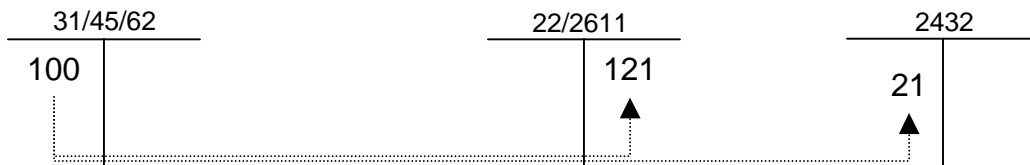

3 – PLC PAP E PAGAMENTO

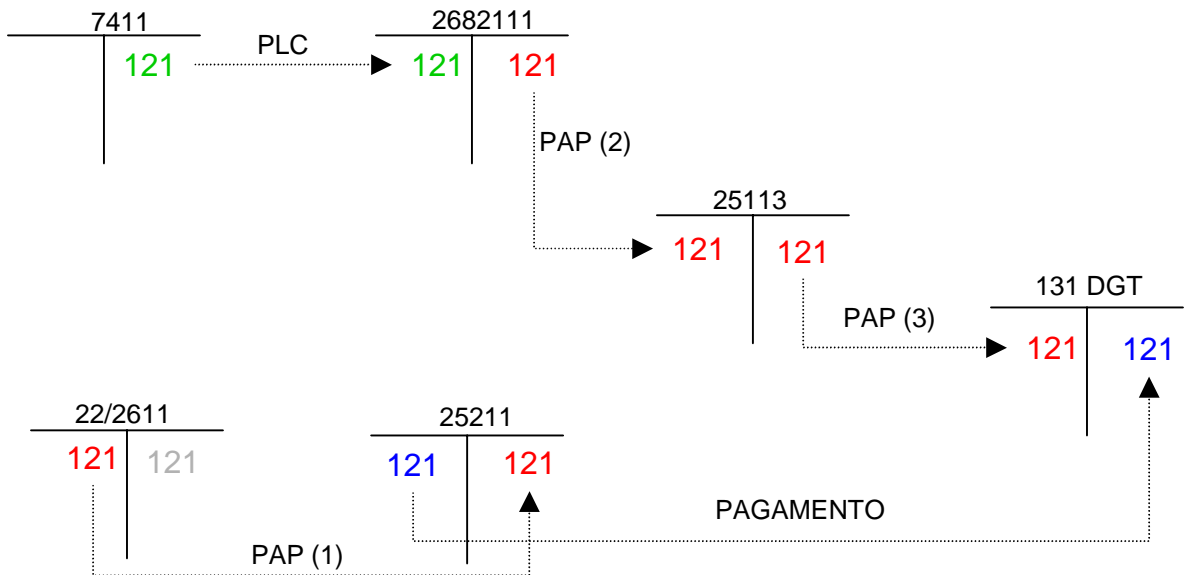

APURAMENTO DO IVA (Com IVA a pagar)

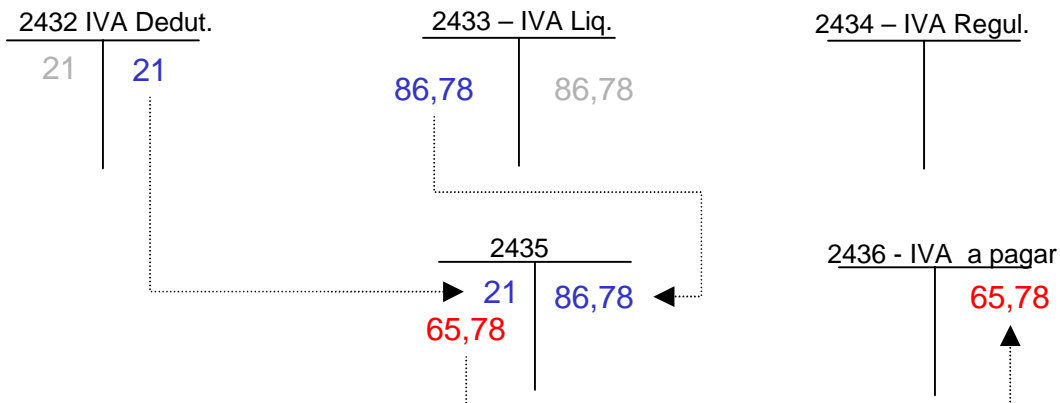

2 - PAGAMENTO DO IVA APURADO (Decl. Periódica)

